

PROFILE A-A

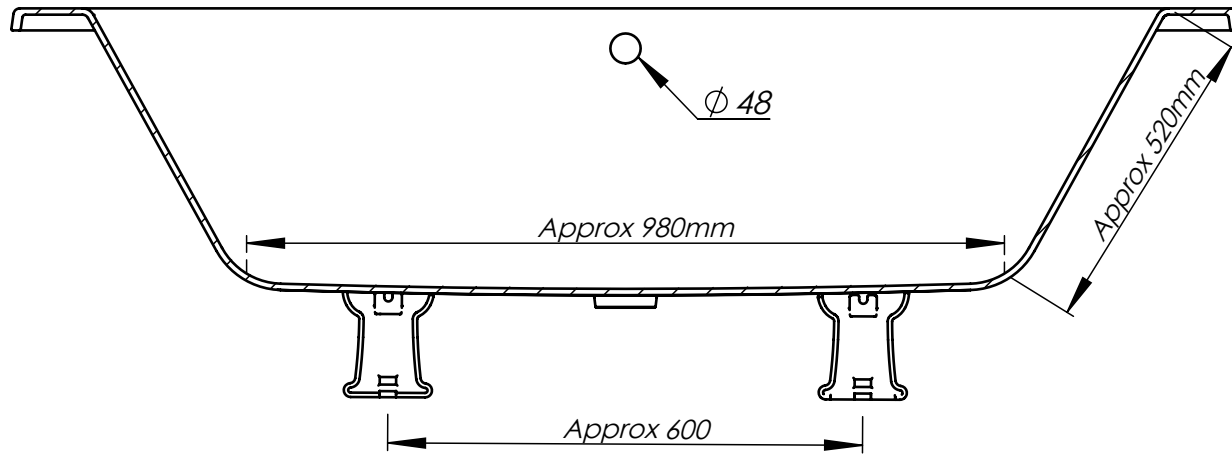

PROFILE B-B

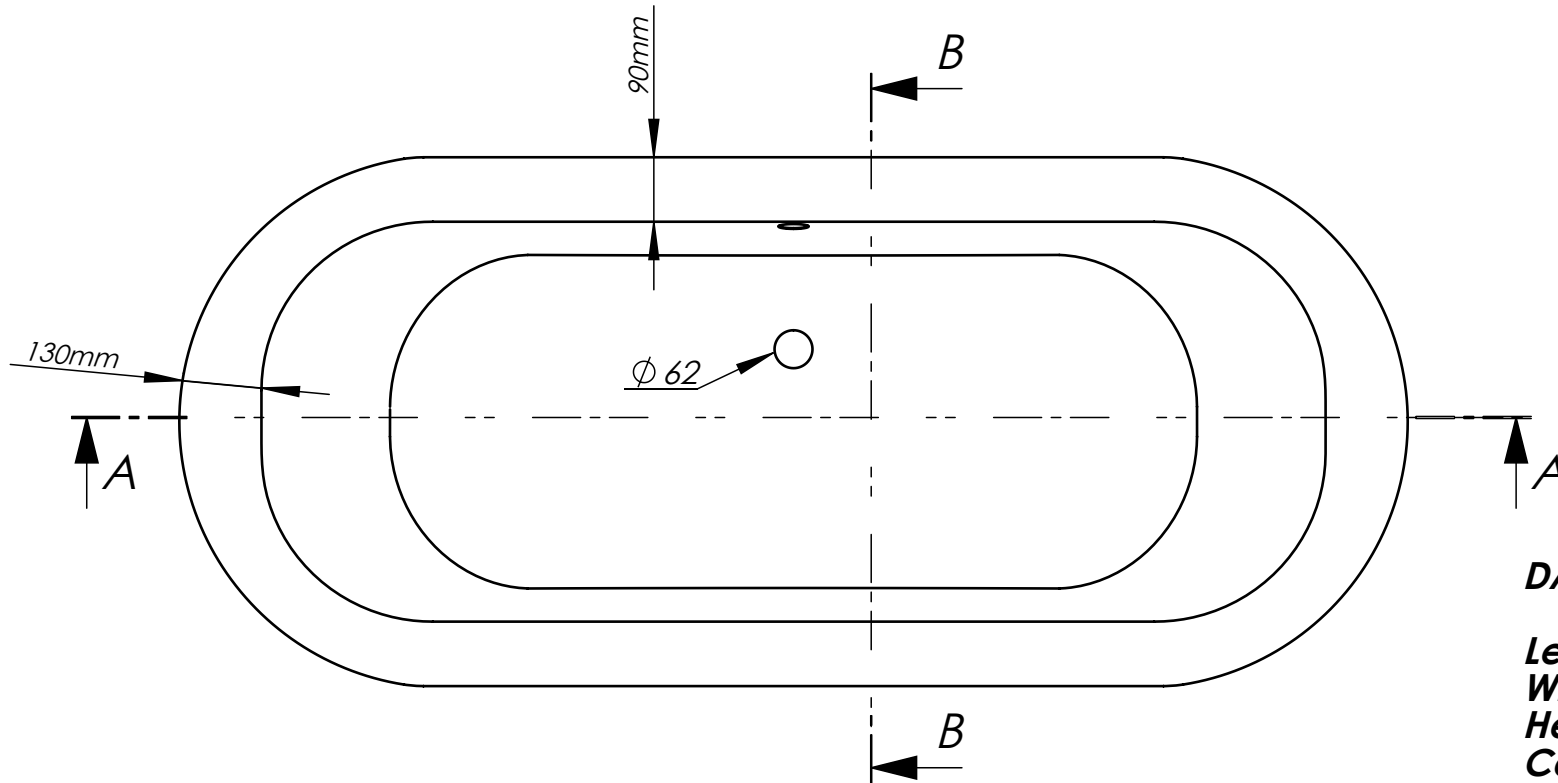
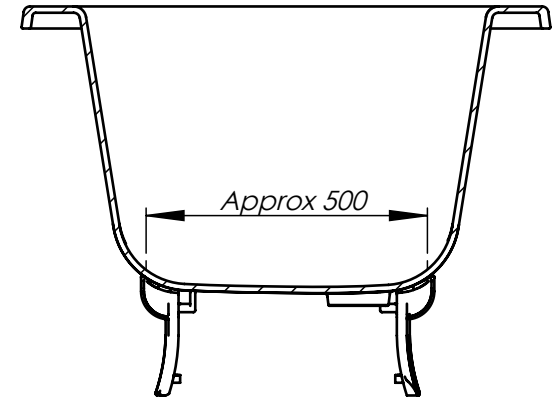

Crate measurements:
 Length - 2005mm
 Width - 950mm
 Height - 760mm

DAD 1012

Length: 1800mm
Width: 880mm
Height: 640mm (with feet)
Capacity: 275 litres
Weight without feet: 156 kg*
Weight with feet: 164 kg*

** Due to hand made process weight can be up to 10 kg more*